













24

	 SERVICE → 
	(0) 91 23 95 50  (0) 17 18 11 43 24 
	(0) 91 23 18 51 55 (0) 91 23 18 52 19 (0) 91 23 30 85
	Service + Spare parts e-mail: service@tadanofaun.de e-mail: spareparts@tadanofaun.de
	D → 00 49
	A B CH DK F GB I N NL P
	E 07 49  S 00 949

TADANO FAUN GmbH
 Postfach 10 02 64
 D-91205 Lauf/Germany
 Tel. (0) 91 23 95 50
 Fax (0) 91 23 30 85
<http://www.tadanofaun.de>
 e-mail: info@tadanofaun.de

ALL-TERRAIN
ATF 30-2L

ISO 9001

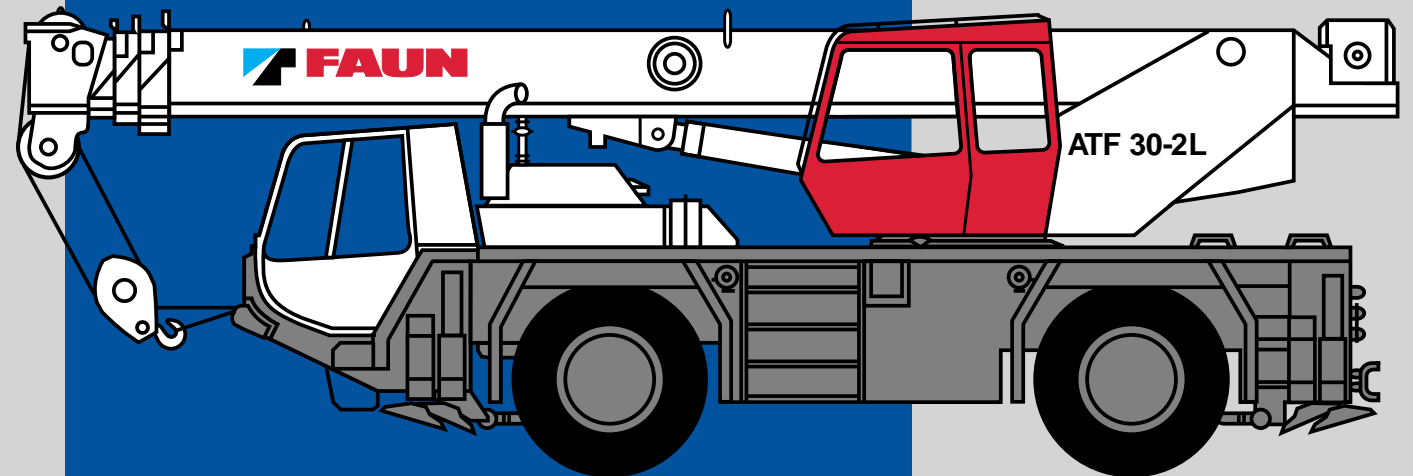

Maße (mm)
 Dimensions (mm)
 Dimensiones (mm)

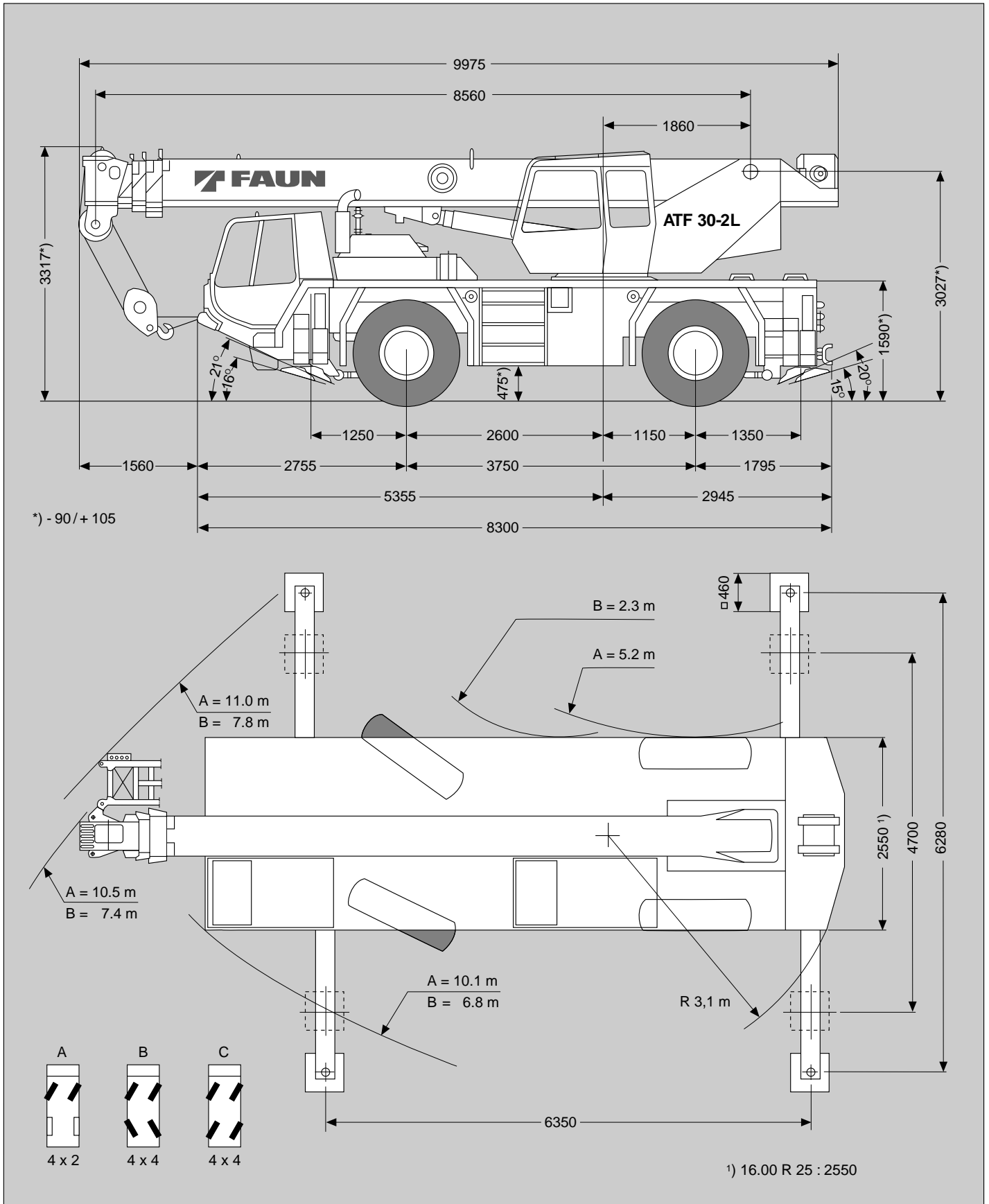
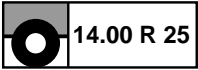

Gewichte / Geschwindigkeiten
Weights / Working speeds
Poids / Vitesses
Pesos / Velocidades de trabajo

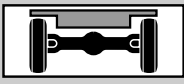
	Achse / Axle Essieu / Eje	1	2	Gesamtgewicht / Total weight Poids total / Peso total
	(t)	12	12	24*

* Incl. 2,6 t Gegengewicht, Bereifung 14.00 R 25, 8 m Gitterspitze, 20 t Unterflasche, 4 t Hakengeschirr, Antrieb 4 x 4, Reserverad.





* Incl. 2.6 t counterweight, tyres 14.00 R 25, 8 m folding swingaway, 20 t hook block, 4 t swivel hook, drive 4 x 4, spare wheel.

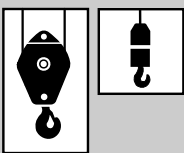

* Incl. de 2,6 t contrepoids, pneus 14.00 R 25, 8 m extension treillis, 20 t moufle, roue de rechange, 4 t elingues, entraînement 4 x 4, roue de rechange.

* Incl. contrapeso de 2,6 t, neumáticos 14.00 R 25, plumín articulado, gancho de 20 t, rueda de repuesto, 4 t gancho de bola, tracción 4 x 4, rueda de repuesto.

	Traglast / Lifting capacity / Force de levage / Capacidad de elevación	Rollen / Sheaves Pulies / Poleas	Stränge / Parts of line Brins / Ramales de cable	Gewicht / Weight Poid / Peso
	32 t	5	11	280 kg
	20 t	3	7	200 kg
	10 t	1	3	150 kg
	4 t	-	1	75 kg



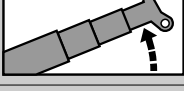
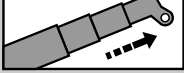

	1	2	3	4	5	6	R		1	2	3	4	5	6	R	
	km/h	10	15	24	36	57	80		10	40%	10	16	26	39	61	
km/h	0-5	0-7	0-11	0-17	0-27	0-41	0-5	74%	0-5	0-8	0-12	0-19	0-29	0-44	0-5	65%
	14.00 R 25								16.00 R 25							

V+ 	Stufenlos Infinitely variable Progressivement variable Infinitamente variable	Seil Rope Câble Cable	Max. Seilzug Max. single line pull Effort maxi au brin simple Trio máximo por ramal
	0 - 120 m/min für einfachen Strang single line au brin simple ramal simple	14 mm / 140 m	39 kN
	0 - 1.6 min ⁻¹		
	-1° - +80° ca. 20 s approx. 20 s env. 20 s aproximadamente 20 s		
	8.6 m - 28.5 m ca. 75 s approx. 75 s env. 75 s aproximadamente 75 s		

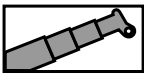
Tragfähigkeiten am
Lifting capacities
Capacités de levage
Capacidades de elevación



 m	8.6	11.9	11.9	15.2	15.2	18.5	18.5	18.5	21.9	21.9	25.2	28.5	
2.7	35.0*												
3.0	30.0	22.0	13.5	22.0	13.5	13.5	13.5	13.5					
3.5	23.4	22.0	13.5	21.5	13.5	13.5	13.1	13.5					
4.0	21.2	20.7	13.5	20.2	13.5	13.5	12.8	13.5	13.5	9.0	11.0		
4.5	19.6	19.3	13.5	18.7	13.5	13.5	12.2	13.5	13.5	9.0	11.0		
5.0	18.7	18.3	13.5	17.3	13.5	13.5	11.3	13.5	13.5	9.0	11.0	9.0	
6.0	14.8	14.3	13.5	14.8	13.5	13.5	9.9	13.5	13.1	8.6	10.6	9.0	
7.0		12.3	13.3	12.0	12.1	12.0	8.9	12.6	11.4	7.8	10.1	8.7	
8.0		10.0	10.7	9.6	10.8	10.0	7.9	10.5	10.0	7.0	9.3	8.2	
9.0		8.3	8.9	7.9	9.1	8.1	7.2	8.6	8.3	6.3	8.3	7.6	
10.0		7.0	7.7	6.6	7.7	6.9	6.6	7.3	7.0	5.8	7.1	7.0	
11.0				5.6	6.7	5.9	6.1	6.3	6.1	5.3	6.1	6.2	
12.0				4.8	5.9	5.1	5.6	5.6	5.3	4.9	5.4	5.5	
14.0						3.9	4.7	4.4	4.0	4.2	4.1	4.2	
16.0						3.0	3.8	3.4	3.1	3.6	3.2	3.3	
18.0									2.5	3.2	2.6	2.7	
20.0									2.0	2.6	2.1	2.2	
22.0											1.7	1.8	
24.0												1.4	
26.0												1.1	
 %	I	0	50	0	100	0	100	0	50	100	0	100	100
	II	0	0	25	0	50	25	75	50	50	100	75	100
	III	0	0	25	0	50	25	75	50	50	100	75	100

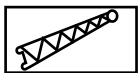
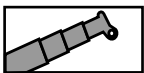

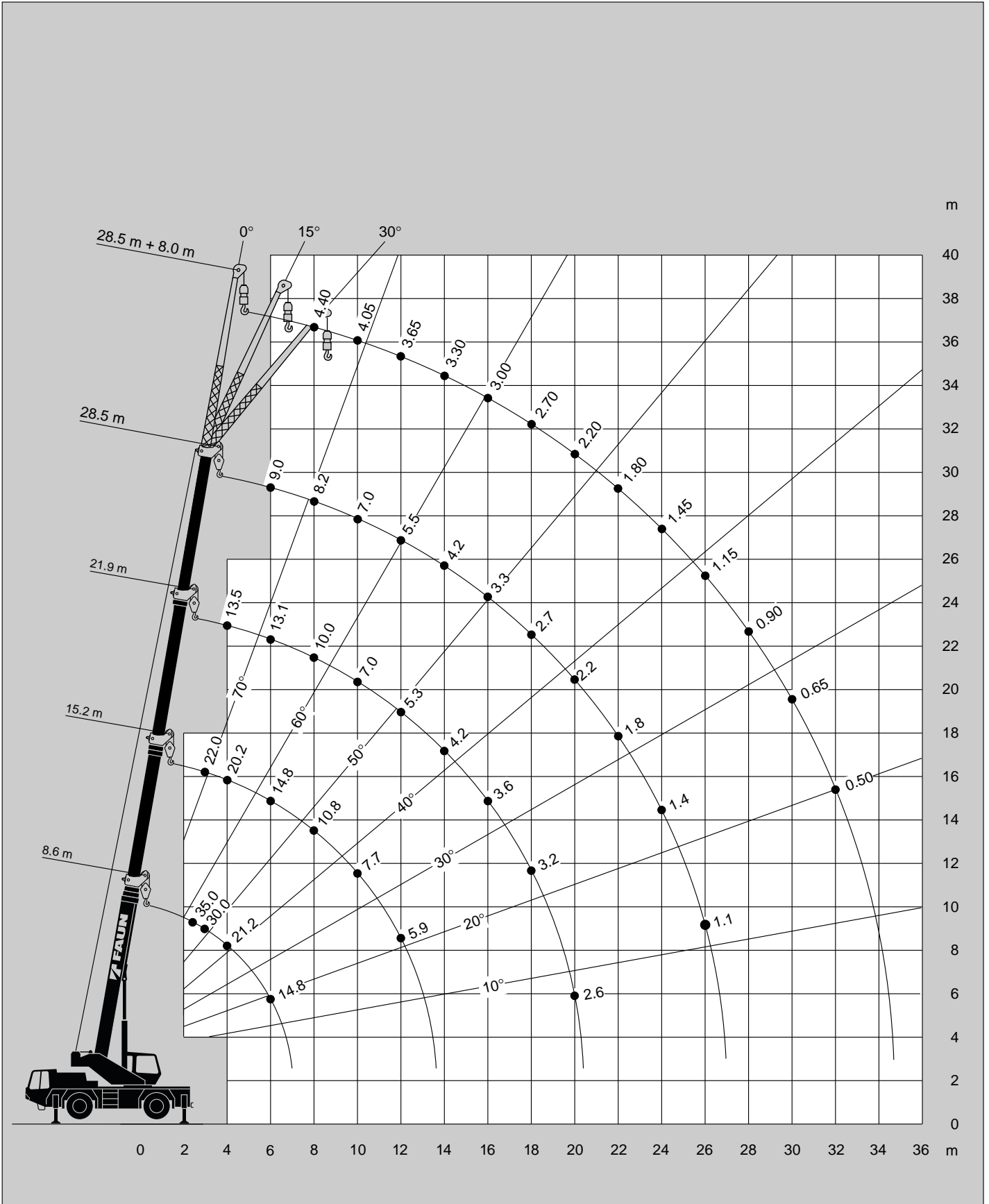
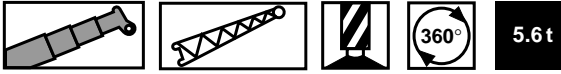

 m	28.5 m + 8.0 m		
	0°	15°	30°
8.0	4.40		
9.0	4.25		
10.0	4.05	2.90	
11.0	3.85	2.80	
12.0	3.65	2.70	2.10
14.0	3.30	2.50	2.00
16.0	3.00	2.35	1.85
18.0	2.70	2.15	1.75
20.0	2.20	2.00	1.65
22.0	1.80	1.85	1.60
24.0	1.45	1.55	1.55
26.0	1.15	1.20	1.25
28.0	0.90	0.95	1.00
30.0	0.65	0.70	0.75
32.0	0.50	0.55	0.55

Hubhöhen
Lifting heights
Hauteurs de levage
Alturas de elevación

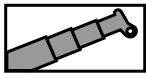

Tragfähigkeiten
Lifting capacities
Capacités de levage
Capacidades de elevación

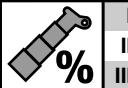

 m	8.6	11.9	11.9	15.2	15.2	18.5	18.5	18.5	21.9	21.9	25.2	28.5	
2.7	35.0*												
3.0	30.0	22.0	13.5	22.0	13.5	13.5	13.5	13.5					
3.5	23.4	22.0	13.5	21.5	13.5	13.5	13.1	13.5					
4.0	21.0	20.7	13.5	20.2	13.5	13.5	12.8	13.5	13.5	9.0	11.0		
4.5	19.3	19.0	13.5	18.7	13.5	13.5	12.2	13.5	13.5	9.0	11.0		
5.0	18.2	18.0	13.5	17.3	13.5	13.5	11.3	13.5	13.5	9.0	11.0	9.0	
6.0	14.3	14.0	13.5	13.7	13.5	13.5	9.9	13.5	13.1	8.6	10.6	9.0	
7.0		10.5	11.3	10.2	11.6	10.6	8.9	11.0	10.8	7.8	10.1	8.7	
8.0		8.3	9.1	8.1	9.2	8.4	7.9	8.8	8.6	7.0	8.6	8.2	
9.0		6.8	7.6	6.4	7.6	6.8	7.2	7.3	7.0	6.3	6.9	7.0	
10.0		5.6	6.4	5.4	6.4	5.7	6.5	6.1	5.8	5.8	5.8	5.9	
11.0				4.5	5.6	4.7	5.6	5.2	4.9	5.3	5.0	5.1	
12.0				3.8	4.8	4.0	4.8	4.5	4.2	4.9	4.4	4.5	
14.0						3.0	3.8	3.4	3.1	3.8	3.3	3.4	
16.0						2.2	3.0	2.6	2.4	3.0	2.5	2.6	
18.0									1.8	2.5	2.0	2.0	
20.0									1.4	2.0	1.5	1.6	
22.0											1.2	1.2	
24.0												0.9	
26.0												0.7	
 %	I	0	50	0	100	0	100	0	50	100	0	100	100
	II	0	0	25	0	50	25	75	50	50	100	75	100
	III	0	0	25	0	50	25	75	50	50	100	75	100

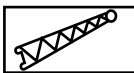
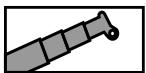

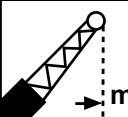
 m	28.5 m + 8.0 m		
	0°	15°	30°
8.0	4.40		
9.0	4.25		
10.0	4.05	2.90	
11.0	3.85	2.80	
12.0	3.65	2.70	2.10
14.0	3.30	2.50	2.00
16.0	2.65	2.35	1.85
18.0	2.10	2.15	1.75
20.0	1.65	1.80	1.65
22.0	1.25	1.35	1.45
24.0	0.95	1.05	1.15
26.0	0.70	0.80	0.85
28.0	0.50	0.55	0.60

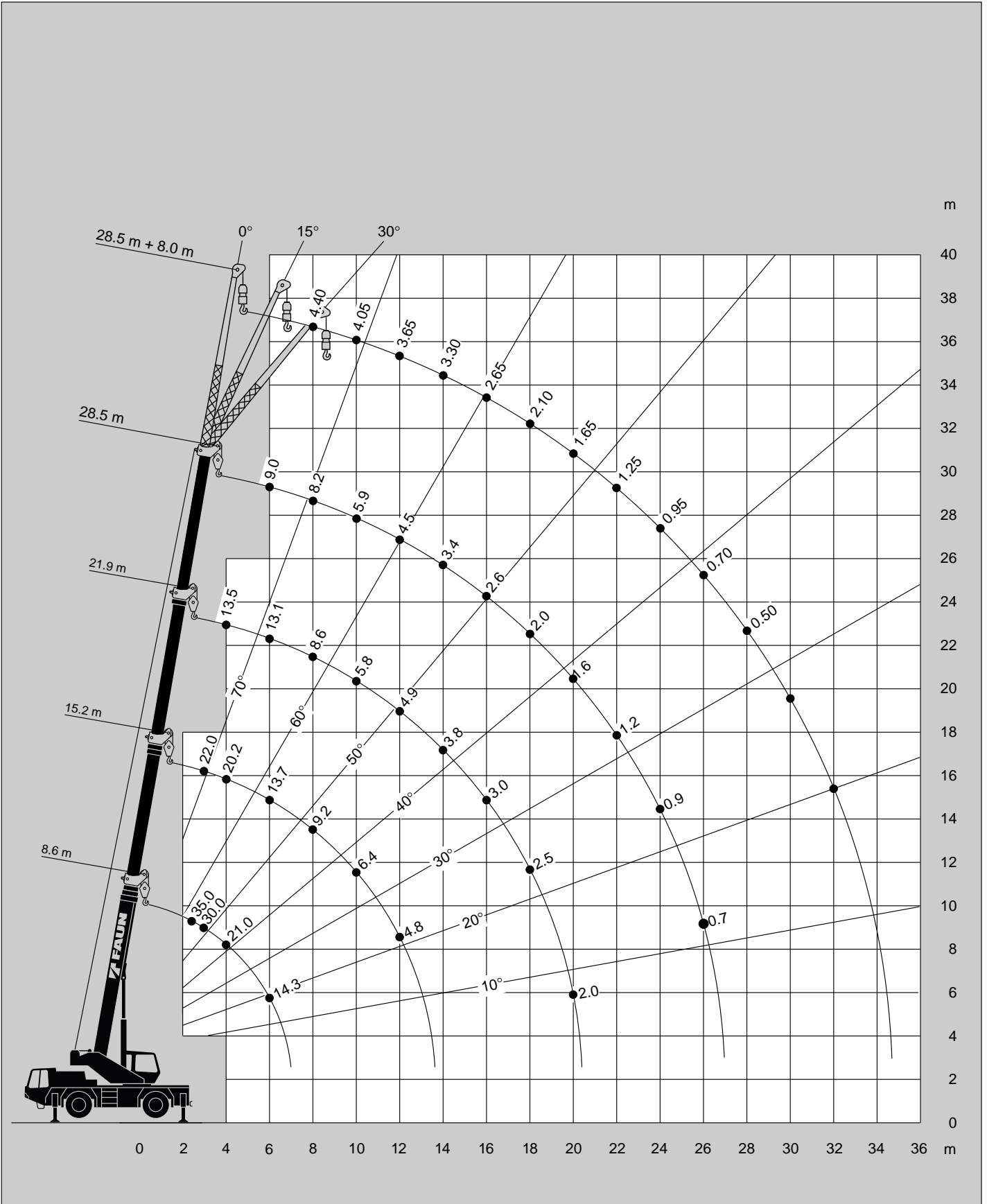
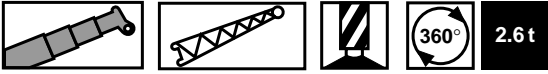

Hubhöhen
Lifting heights
Hauteurs de levage
Alturas de elevación



Tragfähigkeiten
 Lifting capacities
 Capacités de levage
 Capacidades de elevación

Hubhöhen
 Lifting heights
 Hauteurs de levage
 Alturas de elevación



 m	8.6 m	11.9 m	15.2 m	
3.0	11.50	11.80	12.00	
3.5	10.50	10.70	10.80	
4.0	9.55	9.75	9.80	
4.5	8.75	8.95	9.00	
5.0	8.05	8.30	8.40	
6.0	6.75	7.05	7.20	
7.0		5.65	5.80	
8.0		4.60	4.75	
9.0		3.80	3.95	
10.0		3.20	3.30	
11.0			2.75	
12.0			2.30	
 %	I	0	0	0
	II	0	25	50
	III	0	25	50

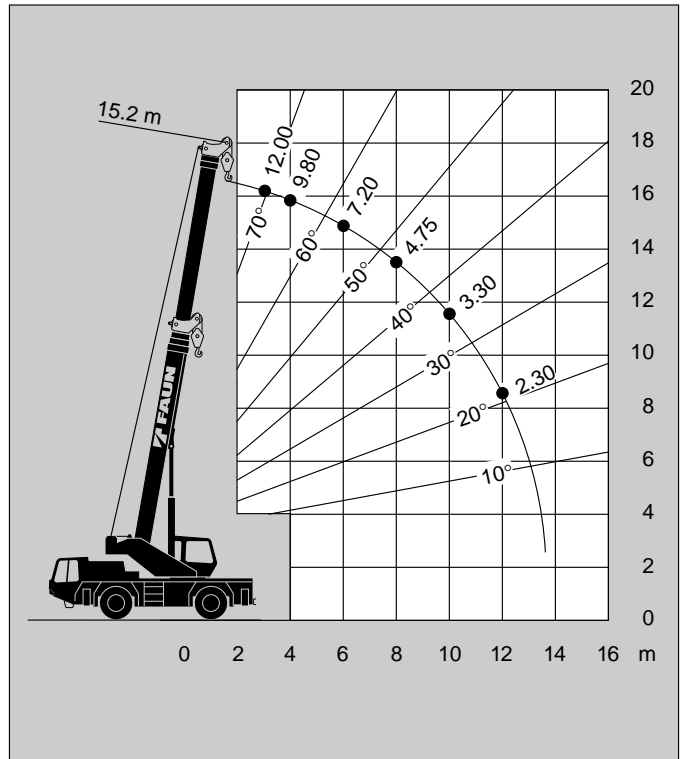

Tragfähigkeiten
Lifting capacities
Capacités de levage
Capacidades de elevación

Hubhöhen
Lifting heights
Hauteurs de levage
Alturas de elevación



→ m	8.6 m	11.9 m	15.2 m	
3.0	11.50	11.80	12.00	
3.5	10.50	10.70	10.80	
4.0	9.55	9.75	9.80	
4.5	8.75	8.95	9.00	
5.0	7.50	7.80	8.00	
6.0	5.65	5.90	6.05	
7.0		4.60	4.80	
8.0		3.70	3.90	
9.0		3.00	3.20	
10.0		2.50	2.65	
11.0			2.20	
12.0			1.85	
%	I	0	0	0
	II	0	25	50
	III	0	25	50

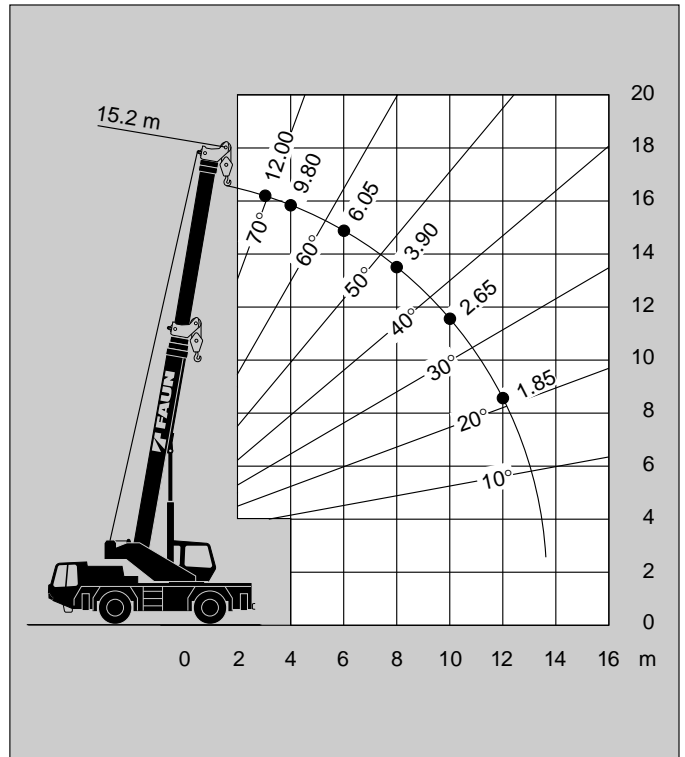

→ m	8.6 m	11.9 m	15.2 m	
3.0	7.00	7.15	7.25	
3.5	5.85	6.05	6.20	
4.0	5.05	5.30	5.45	
4.5	4.45	4.65	4.80	
5.0	3.90	4.10	4.25	
6.0	3.00	3.30	3.45	
7.0		2.50	2.70	
8.0		1.90	2.05	
9.0		1.40	1.55	
10.0		1.05	1.15	
11.0			0.85	
12.0			0.60	
%	I	0	0	0
	II	0	25	50
	III	0	25	50

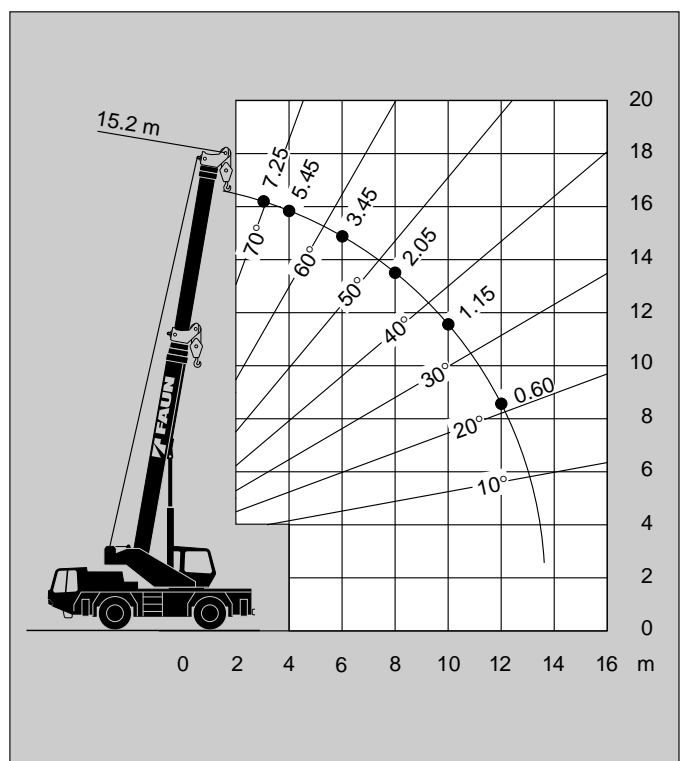

Tragfähigkeiten an der Doppelklappspitze
 Lifting capacities with double-folding boom extension
 Capacités de levage à la fléchette double
 Capacidades de elevación con plumín doble

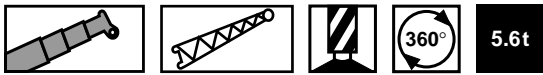

DIN

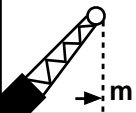
	28.5 m + 7.16 m			28.5 m + 12.20 m		
	0°	15°	30°	0°	15°	30°
8.0	5.00					
9.0	4.90			3.20		
10.0	4.80	3.40		3.05	2.10	
11.0	4.50	3.30		2.95	2.00	
12.0	4.25	3.20	2.40	2.85	1.90	1.40
14.0	3.65	2.90	2.30	2.60	1.75	1.30
16.0	3.20	2.70	2.15	2.25	1.55	1.20
18.0	2.70	2.45	2.05	2.00	1.45	1.15
20.0	2.15	2.25	1.95	1.75	1.35	1.05
22.0	1.75	1.85	1.85	1.60	1.25	1.00
24.0	1.40	1.45	1.50	1.45	1.15	0.95
26.0	1.10	1.15	1.20	1.15	1.05	0.90
28.0	0.85	0.90	0.90	0.90	1.00	0.87
30.0	0.60	0.65	0.65	0.70	0.80	0.85
32.0				0.50	0.60	0.65

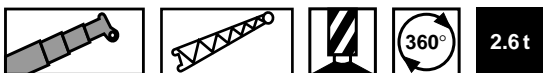

DIN

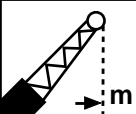
	28.5m + 7.16 m			28.5 m + 12.20 m		
	0°	15°	30°	0°	15°	30°
8.0	5.00					
9.0	4.90			3.20		
10.0	4.80	3.40		3.05	2.10	
11.0	4.50	3.30		2.95	2.00	
12.0	4.25	3.20	2.40	2.85	1.90	1.40
14.0	3.35	2.90	2.30	2.60	1.75	1.30
16.0	2.60	2.70	2.15	2.25	1.55	1.20
18.0	2.00	2.15	2.05	2.00	1.45	1.15
20.0	1.55	1.70	1.75	1.65	1.35	1.05
22.0	1.15	1.25	1.35	1.25	1.25	1.00
24.0	0.85	0.95	1.00	0.95	1.10	0.95
26.0	0.60	0.70	0.75	0.70	0.85	0.90
28.0	0.40	0.45	0.50	0.50	0.60	0.70
30.0					0.40	0.45

Hubhöhen
Lifting heights
Hauteurs de levage
Alturas de elevación

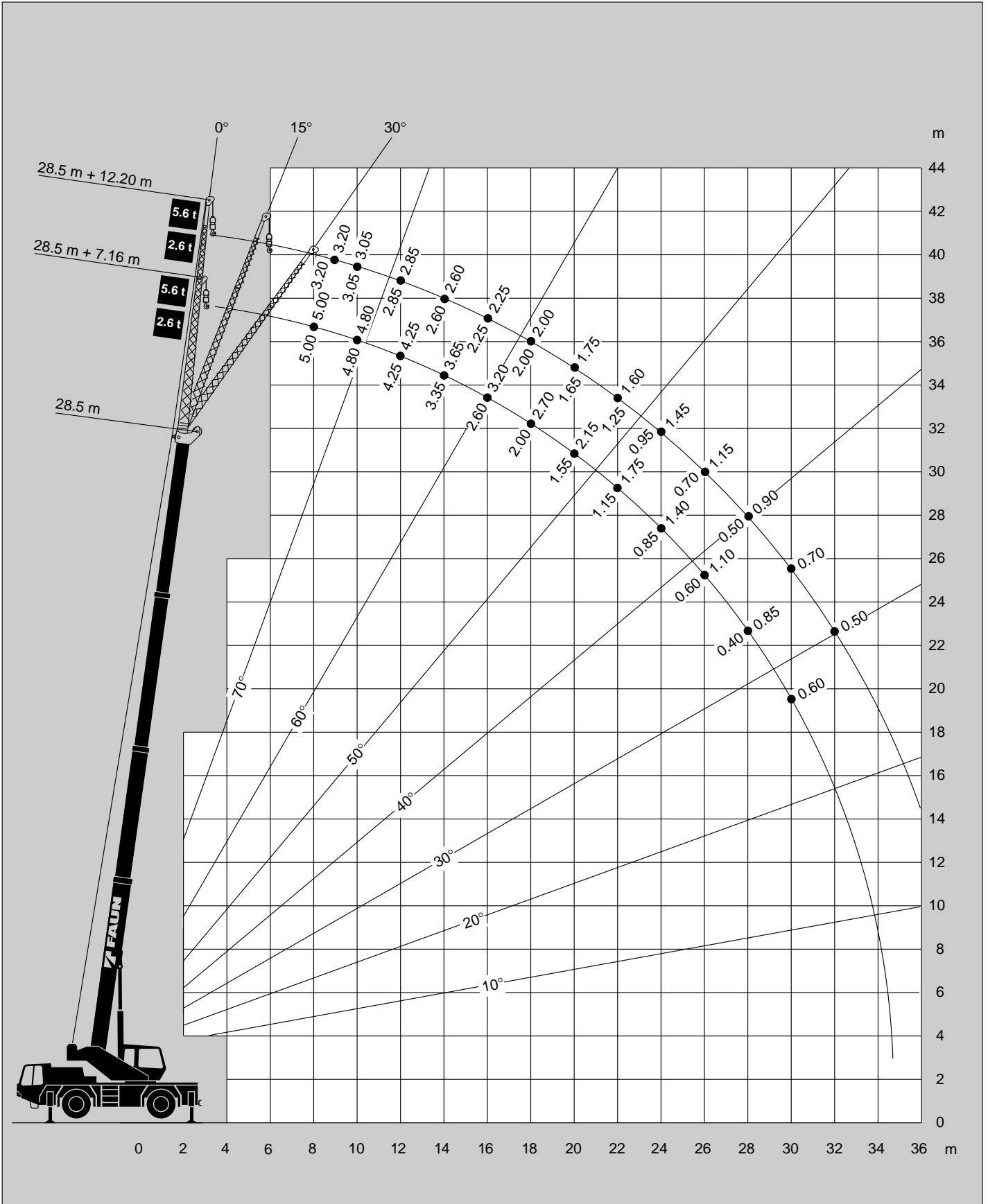

Anmerkungen zu den Traglasttabellen

Die Tragfähigkeiten im Festigkeitsbereich basieren auf DIN 15018 Blatt 2 und Blatt 3 und F.E.M.

Die Tragfähigkeiten im Standsicherheitsbereich entsprechen DIN 15019 Teil 2.

Die zulässige Windgeschwindigkeit beträgt maximal 15 m/sec.

Die Tragfähigkeiten sind in metrischen Tonnen angegeben.

Das Gewicht des Lasthakens bzw. der Hakenflasche und weiterer Anschlagmittel ist von der Tragfähigkeit abzuziehen.

Die Tragfähigkeiten für den Teleskopausleger gelten nur bei demonstrierter Spitze.

Die Ausladung ist der horizontale Abstand von Mitte Drehkranz bis Mitte freihängender, nicht schwingender Last.

Tragfähigkeitsänderungen vorbehalten.

Obige Angaben dienen nur zur Information. Die Bedienungsanleitungen müssen zu Rate gezogen werden, bevor die Maschine in Betrieb genommen wird. Alle hier gemachten Angaben beziehen sich auf die Standard-Ausführung. Jegliche Ausrüstungsveränderungen können die angegebenen Werte beeinflussen.

Remarks relating to the rating charts

The lifting capacities in the structural area are based on DIN 15018 parts 2 and 3 and F.E.M.

The lifting capacities in the stability area are based on DIN 15019 part 2.

The maximum permissible wind speed for crane operation is 15 m/sec.

The lifting capacities shown are in metric tons.

The weight of load handling devices such as hook blocks, slings, etc., must be considered as part of the load and must be deducted from the lifting capacities.

The lifting capacities for the telescopic boom apply to a crane with no boom extensions being stowed or mounted on the crane.

The working radius is the horizontal distance from the centre of rotation to the centre of the freely suspended non-oscillating load.

The lifting capacities are subject to change without prior notice.

The above remarks are for basic information only and the operator's manual must be consulted before operating this crane. All data and performances refer to the standard crane. The addition of optional and other equipment may affect the performance of the crane.

Remarques relatives aux tableaux des charges

Les forces de levage sont conformes aux normes DIN 15018, p. 2 et 3, et F.E.M.

Les forces de levage dans la partie de stabilité au renversement sont conformes aux normes DIN 15019, chap. 2.

La grue peut travailler aux vitesses de vent allant jusqu'à 15 m/s.

Les forces de levage sont données en tonnes métriques.

Le poids du crochet-moufle et de tous les accessoires d'élingage font partie de la charge et sont à déduire des charges indiquées.

Les forces de levage indiquées pour la flèche télescopique s'entendent fléchette déposée.

Comme portée, on entend la distance horizontale du centre de la couronne de rotation au centre de la charge librement suspendue et non oscillante.

Sauf modification de forces de levage.

Les données ci-dessus servent à titre d'information. Avant la mise en marche de la grue il est conseillé d'étudier les instructions de service. Toutes les données indiquées ci-dessus se réfèrent à la machine de base. Tout changement de l'équipement de la grue peut influencer ces valeurs.

Notas relativas a los graficos de carga

En cuanto a los datos referentes a resistencia, las capacidades de carga están basados sobre las normas DIN 15018, pág. 2 y 3, y F.E.M.

En cuanto a los datos referentes a estabilidad anti-vuelco, las capacidades de carga están basados sobre las normas DIN 15019, Cap. 2.

La velocidad anemométrica max. admisible es de 15 m/seg.

Las capacidades de carga indicadas en las tablas corresponden a toneladas métricas.

Hay que deducir los pesos del gancho, eslingas y de otros dispositivos para fijación de cargas de los valores indicados en las tablas.

Las capacidades de carga referentes a la pluma telescópica valen solamente si el plumín está desmontada.

Como alcance se entiende la distancia horizontal desde el centro de la corona de giro hasta el centro de la carga suspendida libremente y no oscilante.

Salvo modificación de capacidades de carga, sin previo aviso.

Los datos arriba indicados sirven solamente para su información. Hay que leer las instrucciones para el uso antes de la puesta en servicio de la máquina. Todos los datos mencionados en las presentes tablas rigen para los modelos standard. Cualquier modificación del equipo montado puede dar lugar a modificaciones de aquellos valores.

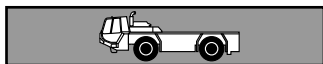

Rahmen Verwindungs- und biegesteife Schweißkonstruktion aus hochfestem Feinkornstahl.

Abstützung 4-Punkt-Abstützung, hydraulisch, Bedienungsmöglichkeiten an beiden Seiten des Fahrgestelles und in der Oberwagenkabine. Abstützbasis 6,28 m (und 4,7 m) x 6,35 m.

Motor Mercedes-Benz 6-Zylinder-Dieselmotor OM 906 LA (EUROMOT 2/EPA 2), wassergekühlt, Leistung 205 kW (279 PS) bei 2200 min⁻¹. Drehmoment 1100 Nm (112 kpm) bei 1200 min⁻¹ bis 1600 min⁻¹.

Getriebe ZF-Lastschaltgetriebe 6 WG 210 mit Drehmomentwandler und "Lock-up" (ab 1. Gang) mit 6 Vorwärts- und 1 Rückwärtsgang.

Antrieb 4 x 4

Achsen

1. Achse: gelenkt, angetrieben, Differentialsperre quer.
2. Achse: gelenkt, angetrieben, Differentialsperre quer.

Achsaufhängung Hydropneumatische Federung mit Niveauregulierung.

Bremsen Druckluft-Zweikreis-Bremsanlage mit ABV-System. Feststellbremse als Federspeicherbremse an der 1. und 2. Achse wirkend. Dauerbremse als Konstantdrosselanlage mit Auspuffklappenbremse.

Räder 4-fach 14.00 R 25

Lenkung ZF-Halbblock-Zweikreishydraulenlenkung. Mechanische Lenkung der 1. Achse, hydraulisch unterstützt, mit Notlenkpumpe. Lenkung beider Achsen möglich. Hydrostatische Lenkung aller Achsen aus der Oberwagenkabine.

Unterswagenkabine Ein-Mann-Frontfahrerhaus in Stahl-Kunststoff-Verbund-Konstruktion, Sicherheitsverglasung, gefederter Fahrersitz und motorabhängige Warmwasserheizung, Kontroll- und Bedienungselemente für den Fahrbetrieb.

Elektrische Anlage 24 Volt-Gleichstrom, 2 Batterien. Die elektrische Anlage entspricht der EG-Norm.

Zusatzrüstung (gegen Mehrpreis) Anhängerkupplung, Zusatzheizung, Zweimann-Fahrerhaus, 16.00 R 25 Bereifung, Reserverad, Sonderlackierung und Beschriftung. Weitere Zusatzrüstung auf Anfrage.



Rahmen Verwindungssteife Schweißkonstruktion mit einer außenverzahnten, einreihigen Kugeldrehverbindung, um 360° unbegrenzt drehbar.

Hydraulik System Diesel-hydraulisch mit 3-Kreishydraulik, 1 leistungsgeregelte Axialkolbendoppelpumpe (hydraulisch verstellbar) und 1 dreifach Zahnradpumpe. Pumpen vom Fahrmotor angetrieben. Bei Kranbetrieb: 195 kW (265 PS) bei 2000 min⁻¹. (DIN 6270B/DIN 6271).

Steuerung Zwei 4-fach Kreuzsteuerhebel mit hydraulischer Vorsteuerung.

Teleskopausleger Vierteiliger, kastenförmiger Teleskopausleger, bestehend aus einem Grundausleger und 3 Teleskopteilen, hydraulisch unter Teillast teleskopierbar. 8,6 m - 28,5 m lang.

Wippwerk Ein Differentialzylinder mit angebautem Senkbremssperrventil.

Hubwerk Axialkolben-Konstant-Motor, Hubwerkstrommel mit eingebautem Planetengetriebe und federbelasteter Hydro-Lamellenbremse mit integriertem Freilauf beim Heben. Hubseil mit "Superstop"-Einrichtung.

Drehwerk Konstant-Motor, zweistufiges Planetengetriebe mit fußbetätigter Betriebsbremse und Feststellung. Drehgeschwindigkeit stufenlos von 0 - 1,6 min⁻¹.

Gegengewicht Gesamtgewicht 2,6 t.

Oberwagenkabine Großräumige Krankabine in Stahlblechausführung mit Sicherheitsverglasung mit getönten Scheiben, verstellbarem hydraulisch gedämpftem Fahrersitz, motorunabhängige Warmluftheizung, Kontroll- und Bedienungselemente für Kranbetrieb, Verfahrbarkeit vom Oberwagen und Abstützbetätigung.

Elektrische Anlage 24 Volt-Gleichstrom.

Sicherheitseinrichtungen Lastmomentbegrenzung (LMB), Hubendschalter, Windenendschalter, Seilwindendrehmelder, Sicherheitsventile gegen Rohr- und Schlauchbrüche. Sperrventile an Hydraulik-Zylindern.

Zusatzrüstung (gegen Mehrpreis) Auslegerverlängerungen: Klappspitze 8,0 m lang, Doppelklappspitze 7,1 m - 12,2 m lang, (alle abwinkelbar 0°, 15° und 30°), Zusatzgegengewicht 3 t, 4 t Hakengeschirr, 10 t Unterflasche, 20 t Unterflasche, 32 t Unterflasche, Ölkühler, Sonderlackierung und Beschriftung. Weitere Zusatzrüstung auf Anfrage.

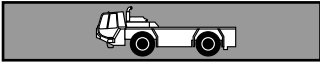

Frame Torsion resistant, welded construction made from high strength, fine-grained steel.

Outriggers 4 point hydraulic outriggers with controls on both sides of carrier and in superstructure cab. Outrigger base 6.28 m (and 4.7 m) x 6.35 m.

Carrier engine Mercedes-Benz 6 cylinder model OM 906 LA (EUROMOT 2/EPA 2), water-cooled diesel engine. Rated at 205 kW (279 HP) at 2200 rpm. Torque 1100 Nm (112 kpm) at 1200 rpm - 1600rpm.

Transmission ZF Powershift transmission 6 WG 210 with hydrodynamic torque converter (with "lock-up" from 1st gear) and with 6 forward gears and 1 reverse gear.

Drive 4 x 4

Axles

1st axle: steered, driven, with differential lock.

2nd axle: steered, driven, with differential lock.

Suspension Hydro-pneumatic with levelling adjustment.

Brake system Service brakes: dual circuit compressed air system with ABS. Parking brake: spring loaded type acting on 1st and 2nd axles. Auxiliary brakes: engine exhaust brake and constant throttle engine brake system.

Tyres (4) 14.00 R 25.

Steering system From carrier cab: ZF semi-block dual circuit hydraulic steering, mechanical steering of front axle with hydraulic assistance and emergency steering pump. Steering of both axles possible. All axles steered hydrostatically from superstructure cab.

Carrier cab One-man full width cab of composite (steel sheet metal and fibre-glass) structure, with safety glass, spring-cushioned adjustable seat, engine dependent hot-water heater. Complete controls and instrumentation for road travel.

Electrical system 24 volt DC system, 2 batteries, conforms with EEC-regulations.

Optional Equipment (at extra charge) Towing attachment, additional heater, two-man carrier cab, 16.00 R 25 tyres, spare wheel and tyre, special painting and lettering. Further optional equipment available upon request.

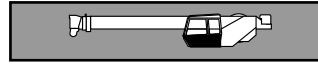

Frame Torsion-resistant, all-welded structure of high strength steel. Connected to carrier by single-row ball-bearing slewing ring with external gearing for 360° continuous rotation.

Hydraulic system Three circuit diesel hydraulic system with 1 double axial piston variable displacement pump (hydraulically adjustable) and 1 triple gear pump. Pumps driven by carrier engine rated at 195 kW (265 HP) at 2000 rpm. (DIN 6270B/DIN 6271).

Controls Hydraulic, 2 joy-stick levers for simultaneous operation of crane motions.

Telescopic boom 4 section box type construction of high tensile, fine-grained steel, consisting of 1 base section and 3 telescoping sections. All telescope sections extendable under partial load. 8.6 m to 28.5 m long.

Derricking system 1 double acting hydraulic cylinder with integral brake and holding valve.

Main winch Axial piston constant displacement motor, winch drum with integrated planetary reduction and with hydraulically controlled spring-loaded, multiple disc brake and with integrated free rotation (no sagging of load when hoisting). Hoist cable with "Superstop" easy reeving system.

Slewing system Constant displacement motor with two-stage planetary reduction with a foot actuated service and a parking brake. Speed infinitely variable 0 - 1.6 rpm.

Counterweight Standard 2,6 t.

Superstructure cab Spacious all-steel panoramic cab with safety (tinted) glass windows, hydraulically-cushioned adjustable seat, engine independent hot air heater. Complete controls and instrumentation for crane operation, on-site travelling and outriggers.

Electrical system 24 volt DC system.

Safety devices Load moment device (LMD), hoist limit switch, lower limit switch, drum turn indicator, safety valves against pipe and hose rupture, holding valves on hydraulic cylinders.

Optional Equipment (at extra charge) Lattice boom extensions: single folding 8.0 m long, double-folding 7.1 m - 12.2 m long (both with offsets 0°, 15° and 30°), additional counterweight 3 t, 4 t headache ball, 10 t hook block, 20 t hook block, 32 t hook block, oil cooler, special painting and lettering. Further optional equipment available upon request.

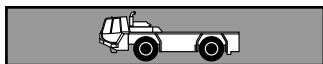

Châssis Construction mécano-soudée, en acier fin, résistante aux fléxions et aux torsions.

Calage Calage à 4 points, complètement hydraulique. Commande des stabilisateurs latéralement à gauche et à droite du châssis et à partir de la cabine du grutier. Calage 6,28 m (aussi 4,7 m) x 6,35 m.

Moteur Mercedes-Benz diesel de 6 cylindres, modèle OM 906 LA (EUROMOT 2/EPA 2), refroidi par eau, de 205 kW (279 CV) à 2200 tr./min. Couple: 1100 Nm (112 kpm) à 1200 tr./min - 1600 tr./min.

Boîte de vitesse Boîte powershift ZF 6 WG 210, avec convertisseur de couple et embrayage "Lock up" (à partir de la 1^{ère} vitesse), avec 6 vitesses AV et 1 vitesse AR.

Entraînement 4 x 4

Essieux

1^{er} essieu: directeur, entraîné, blocage de différentiel entre-roues

2^{ème} essieu: directeur, entraîné, blocage de différentiel entre-roues

Suspension Hydro-pneumatique, avec réglage de niveau

Freins Système à air comprimé, à double circuit, avec système ABS. Frein de stationnement: avec accumulateurs à ressort agissant sur le 1^{er} et 2^{ème} essieu. Frein continu: Frein sur échappement avec étrangleur

Pneus 4 x 14.00 R 25

Direction Semi-bloc à double circuit, marque ZF. Direction mécanique du 1^{er} essieu, à assistance hydraulique, avec pompe de direction auxiliaire. Direction des 2 essieux possible. Direction hydro-statique de tous les essieux depuis la cabine du grutier.

Cabine Cabine mono-place, construction en matière combinée acier / synthétique. Vitrage en verre de sécurité, siège du conducteur à ressort. Chauffage à eau chaude relié au moteur. Organes de contrôle et de commande pour la conduite.

Système électrique 24 V courant continu, 2 batteries, conforme aux normes CE.

Équipement supplémentaire (contre supplément de prix) Attache-remorque, chauffage auxiliaire, cabine bi-place, pneus 16.00 R 25, roue de secours, peinture spéciale et inscription. Autres équipements supplémentaires sur demande.



Plate forme Construction mécano-soudée résistante à la torsion. Couronne d'orientation à billes à une rangée, à denture extérieure, permettant une rotation illimitée sur 360°.

Système hydraulique Diesel-hydraulique à 3 circuits, 1 double pompe à pistons axiaux à régulation de puissance (à réglage hydraulique) et 1 pompe triple à engrenages. Actionnement des pompes par le moteur. Puissance pour travaux de grue 195 kW (265 CV) à 2000 tr./min. selon DIN 6270B / DIN 6271.

Commande 2 manipulateurs à commande en croix (4 sens), assistés hydrauliquement.

Flèche télescopique 1 flèche de base et 3 éléments télescopiques, hydrauliquement télescopables aussi sous charge partielle. Flèche en forme de caisson avec une logueur de 8,6 m à 28,5 m.

Mécanisme de relevage 1 vérin différentiel muni de clapet de freinage de descente.

Mécanisme de levage Moteur hydraulique, tambour de levage avec boîte planétaire incorporée, frein d'arrêt à disques multiples à ressort, libéré lors du levage. Câble de levage avec dispositif "Super-Stop".

Orientation Moteur hydraulique avec entraînement planétaire à 2 gammes. Frein de service actionné par l'intermédiaire d'une pédale et frein de stationnement. Vitesse de rotation 0 à 1,6 tr./min. en continu.

Contrepoids Poids total 2,6 t.

Cabine du grutier Cabine de grue spacieuse, en acier, avec vitrage de sécurité en verre teinté, siège réglable et amorti hydrauliquement, chauffage à air chaud indépendant du moteur, éléments de commande et de contrôle pour travaux sur chantier, conduite et calage de la grue depuis la cabine du grutier.

Système électrique 24 V courant continu, 2 batteries.

Dispositifs de sécurité Limiteur de charge (CEC), interrupteur de fin de course de levage et de treuil, indicateur du nombre de tours, soupapes de sécurité contre ruptures des conduites et flexibles, clapets sur vérins hydrauliques.

Équipement supplémentaire (contre supplément de prix) Fléchette en treillis de 8 m rabattable, fléchette double de 7,1 m à 12,2 m rabattable (toutes inclinables à 0° / 15° et 30°), contre-poids additionnel de 3 t, crochet de 4 t, mofles de 10 t, 20 t et 32 t, refroidisseur d'huile, peinture spéciale et inscription. Autres équipements supplémentaires sur demande.

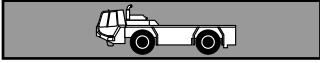

Chasis portante Construcción de acero de alta resistencia soldado, resistente a la torsión y a la flexión.

Estabilizadores Estabilizadores hidráulicos de 4 puntos. Posibilidad de manejo desde ambos lados del chasis portante y desde la cabina de la grúa. Extensión de los estabilizadores: 6,28 m (y 4,70 m) x 6,35 m.

Motor Mercedes-Benz modelo OM 906 LA (EUROMOT 2 / EPA 2), 6 cilindros, diesel, refrigerado por agua. Nominal 205 kW (279 HP) a 2200 rpm. Par 1100 Nm (112 kpm) a 1200 rpm - 1600 rpm.

Transmisión Transmisión ZF tipo powershift 6 WG 210, con convertidor de par. Convertidor con embrague "lock-up" (a partir de la 1ª marcha). 6 marchas adelante y 1 marcha atrás.

Tracción 4 x 4

Ejes

1º eje: de dirección, accionado, con bloqueo diferencial transversal

2º eje: de dirección, accionado, con bloqueo diferencial transversal

Suspensión Suspensión hidroneumática con regulación de nivel.

Sistemas de frenos Accionamiento neumático de doble circuito con sistema anti bloqueo ABS. Freno de estacionamiento del tipo muelles cargados, liberados por aire, sobre los ejes 1º y 2º. Freno continuo: sistema estrangulador constante y freno tipo estrangulación sobre el escape del motor diesel.

Neumáticos 4 x 14.00 R 25

Dirección Hidráulica ZF de doble circuito con semibloqueo. Giro mecánico sobre el 1º eje, asistido hidráulicamente. Bomba hidráulica de emergencia accionada por la transmisión. Dirección de los 2 ejes posible. Desde la cabina de la superestructura: dirección hidro-estática de ambos ejes.

Cabina Cabina en el lado izquierdo para una persona, en construcción de acero y fibra de vidrio. Cristales de seguridad, asiento con suspensión de resorte, calefacción por agua caliente del motor. Elementos de control e instrumentos para circulación por carretera.

Sistema eléctrico Sistema de 24 V c.c. con 2 baterías, de acuerdo con las normas CE.

Equipo adicional (con suplemento de precio) Embrague de remolque, calefacción adicional, cabina para dos personas, neumáticos 16.00 R 25, rueda de repuesto, pintura especial e inscripción. Otros equipos adicionales bajo demanda.



Superestructura Construida en aceros soldados, resistente a la torsión. Corona de giro con rodamiento de una fila de bolas con dientes externos para giro continuo de 360°.

Sistema hidráulico Sistema hidráulico de 3 circuitos, 1 bomba doble de pistones axiales de caudal variable (regulable hidráulicamente) y una bomba triple de engranajes. Accionamiento de las bombas por el motor. Salida del motor para operación de la grúa: 195 kW (265 HP) a 2000 rpm. según DIN 6270B / DIN 6271.

Mandos 2 palancas de control de tipo joy-stick para movimientos simultáneos de la grúa (4 direcciones), asistidos hidráulicamente.

Pluma telescópica 4 secciones del tipo cajón, un tramo base y 3 telescópicos. Los tramos se pueden telescopar hidráulicamente bajo carga. Longitud de 8,6 m a 28,5 m.

Elevación de pluma Mediante un cilindro hidráulico de doble efecto con válvula de retención integrada.

Cabrestante principal Motor hidráulico de pistones axiales y caudal fijo. Tambor del cabrestante con reducción planetaria y freno de discos múltiples con muelles cargados. Cable de elevación con sistema de enhebrado fácil y "Super-Stop".

Sistema de giro Motor hidráulico con reducción planetaria de dos etapas. Freno de servicio controlado por pedal y freno de estacionamiento. Velocidad de giro variable de 0 a 1,6 rpm.

Contrapeso Peso total de 2,6 t.

Cabina de la grúa Cabina espaciosa, construida en acero, con cristales coloreados de seguridad. Asiento del operador regulable amortiguado hidráulicamente, calefacción por aire caliente independiente del motor. Controles, instrumentos y mandos de conducción para la operación de la grúa y para el desplazamiento en obra. Mandos para nivelación y extensión de los estabilizadores.

Sistema eléctrico Sistema de 24 V c.c. con 2 baterías.

Dispositivos de seguridad Dispositivo de momento de carga, interruptor de límite de elevación y de carrera del cabrestante. Indicador de vueltas del tambor. Válvulas de seguridad contra rotura de tuberías y latiguillos, válvulas de retención en los cilindros hidráulicos.

Equipo adicional (con suplemento de precio) Plumines: Plumín plegable de 8 m, plumín doble plegable de 7,1 m a 12,2 m (todos acodable en 0° / 15° y 30°), contrapeso suplementario de 3 t, gancho de bola de 4 t, ganchos de 10 t, 20 t y 32 t, refrigerador de aceite, pintura especial e inscripción. Otros equipos adicionales bajo demanda.

Hakenhöhen/Kopfhöhen
 Hook height/Tip height
 Hauteurs sous crochet/ Hauteurs tête de flèche
 Altura del gancho / Altura de la punta

